



HV Pro Handset Guide – Yealink T48U

Red5 Networks Limited

Issue 1 – April 2022

Confidentiality

All information in this document is provided in confidence as per the terms and conditions of HV Pro and shall not be published or disclosed wholly or in part to any other party without prior permission in writing. These obligations shall not apply to information which is published or becomes known legitimately from some source other than Red5 Networks.

Contents

Confidentiality	2
Yealink SIP-T48U	4
Phone Installation	5
Provisioning	8
Getting to know your phone	9
Hardware Component Instructions	9
Icon Instructions	10
Phone Display (Views)	12
Basic Call Features	14
Placing Calls	14
Answering Calls	15
Transferring Calls	15
Ending Calls	16
Conference Calls	16
Do Not Disturb (DND)	17
History	17
Contact Directory	18
Voicemail	19
Additional Features	19
Headset	19
Bluetooth Dongle	19
Wi-Fi Dongle	20
Expansion Module	20
General information	20
Product Support & Fault Handling	21

Yealink SIP-T48U

WHC IP Phone User guide



This user guide provides you with all the information you need to get the most from your phone. You must first set up your phone before you can use it. This doesn't take long as it is easy to do. Just follow the simple instructions in this user guide or the quick start guide included with the phone.

Got everything?

- IP Phone
- Handset
- Handset cord
- Ethernet cable
- Phone stand
- Quick start guide
- Power adapter (Optional)
- Wall mount bracket (Optional)

Need help?

If you have any problems setting up or using your Yealink IP Phone, please contact our support desk.

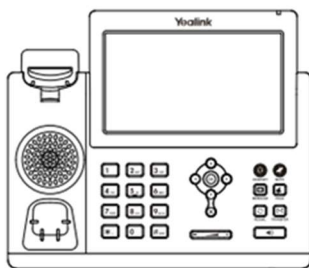

IP Phone



Handset



Handset Cord

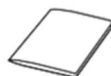

Quick Start Guide



Ethernet Cable
(2m CAT5E UTP Cable)



Power Adapter
(Optional)



Stand

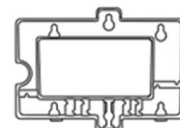

Wall Mount Bracket
(Optional)

Emergency Calls – important information please note

Access to Emergency Services is provided but calls including emergency calls to 999 or 112, made via WHC may not work in the event of power or broadband connection failure. These failures may be caused by reasons outside our control. Location information, provided to the emergency services, is limited to the location details entered into the system by your Service Provider; this may not be where the call was originated.

Phone Installation

1. Attach the stand or the optional wall mount bracket

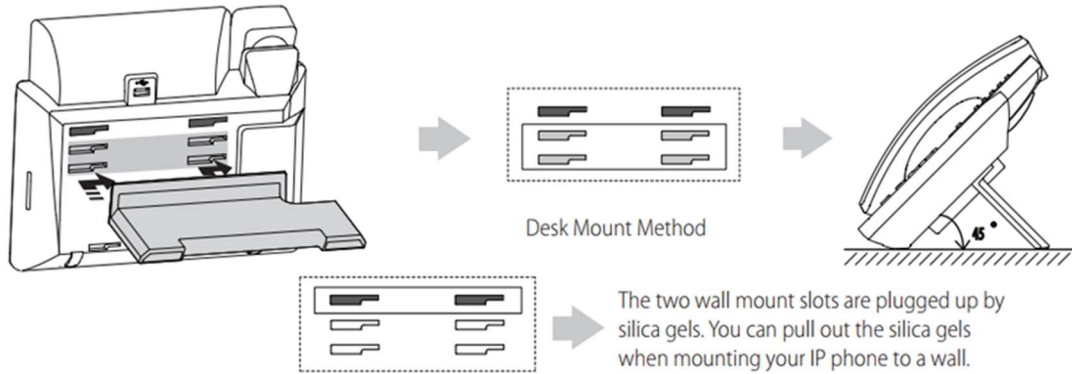

Wall Mount Method (Optional)

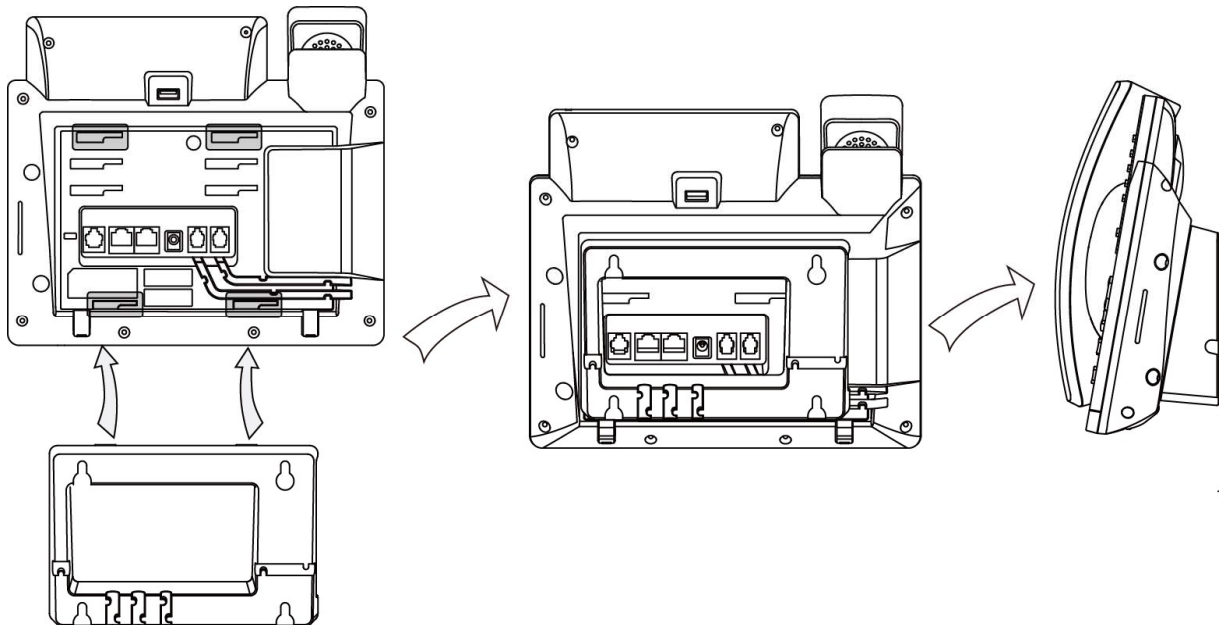

2. Connect the handset and optional headset

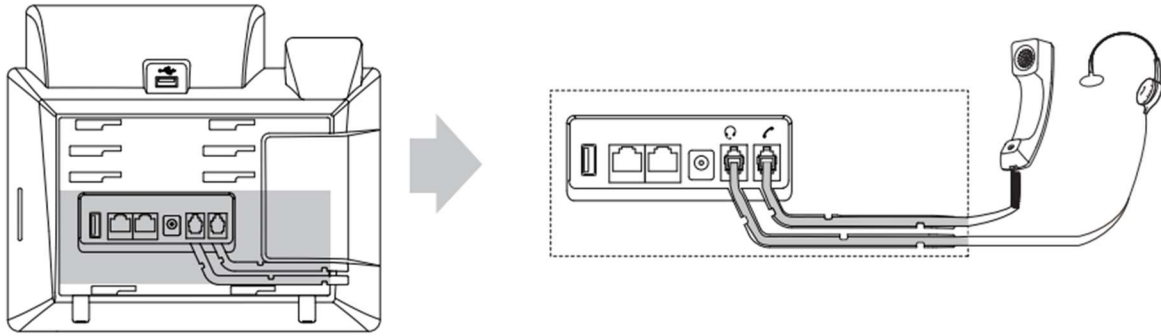

3. Connect the USB flash drive

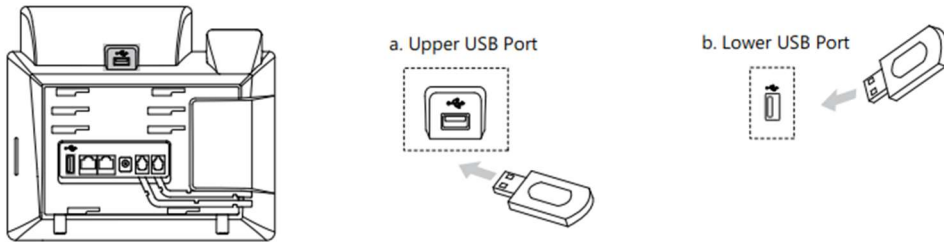

4. Connect the network and power

You have two options for power and network connections. Your system administrator will advise you which one to use.

- AC power (Optional)
- Power over Ethernet (PoE)

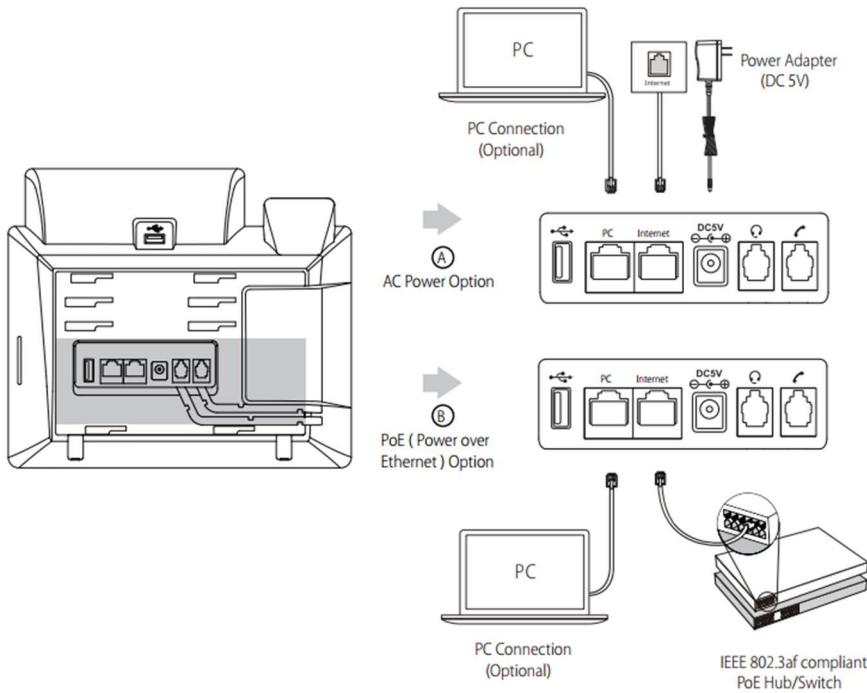

AC Power (Optional)

To connect the AC power:

1. Connect the DC plug on the power adapter to the DC5V port on the phone and connect the other end of the power adapter into an electrical power outlet.
2. Connect the included or a standard Ethernet cable between the Internet port on the phone and the one on the wall or switch/hub device port.

Power over Ethernet

With the included or a regular Ethernet cable, the SIP-T48U IP phone can be powered from a PoE-compliant switch or hub. To connect the PoE:



1. Connect the Ethernet cable between the Internet port on the phone and an available port on the in-line power switch/hub.

If in-line power switch/hub is provided, you don't need to connect the phone to the power adapter. Make sure the switch/hub is PoE-compliant. The phone can also share the network with another network device such as a PC (personal computer). It is an optional connection. Important, do not unplug or remove power to the phone while it is updating firmware and configurations.

Provisioning

Your Yealink SIP-T48U IP Phone will be pre-loaded with all the information it needs to automatically provision the WHC service once all the connections have been made.

- Once connected to the network port that is providing network access the phone will do a series of firmware updates (please allow the phone time to complete).

- Your phone has provisioned correctly if this symbol is showing against the phones line key 
- Your phone has not provisioned correctly if this symbol is showing against the phones line key 

- Once complete the phone will now show the line number against a line key.









Note: If the handset fails to provision please contact our support desk.

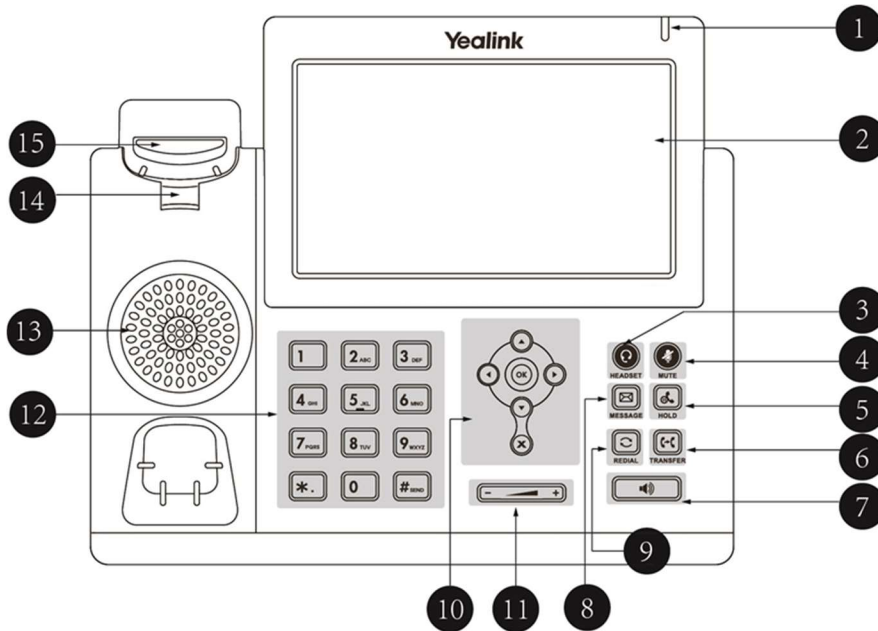

Getting to know your phone

Hardware Component Instructions

The main hardware components of the SIP-T48U IP phone are the LCD screen and the keypad.



























	Item	Description
①	Power Indicator LED	Indicates phone power and some feature statuses.
②	Touch Screen	The screen is touch-sensitive. Tap to select and highlight screen items. Shows information about calls, messages, soft keys, time, date and other relevant data: <ul style="list-style-type: none"> • Call information—caller ID, call duration • Icons (for example, ) • Missed call text or second incoming caller information • Prompt text (for example, "Saving config file! ") • Time and date
③	HEADSET Key	Toggles and indicates the headset mode.
④	MUTE Key	Toggles and indicates mute feature.
⑤	HOLD Key	Places a call on hold or resumes a held call.
⑥	TRANSFER Key	Transfers a call to another party.
⑦	Speakerphone Key	Toggles the hands-free speakerphone mode.
⑧	MESSAGE Key	Accesses voice messages.
⑨	REDIAL Key	Redials a previously dialed number.
⑩	 	Position the cursor within text you're updating. Enable or disable fields.
	 	Turn pages or scroll through values for a field.

		Scroll through items. Access to History and Directory respectively.
		Confirms actions or answers incoming calls.
		Cancels actions or rejects incoming calls.
⑪	Volume Key	Adjusts the volume of the handset, headset and speaker. If you adjust the volume for handset or headset to level 12-15 on a call, on the next call the volume will be reduced back to level 11 to protect your hearing.
⑫	Keypad	Provides the digits, letters and special characters in context-sensitive applications.
⑬	Speaker	Provides ringer and hands-free (speakerphone) audio output.
⑭	Hookswitch Tab	Secures the handset in the handset cradle when the IP phone is mounted vertically.
⑮	Hookswitch	Picking up the handset from the handset cradle, the hookswitch bounces and the phone connects to the line, laying the handset down on the handset cradle, the phone disconnects from the line.

Icon Instructions

Icons appearing on the LCD screen are described in the following table:



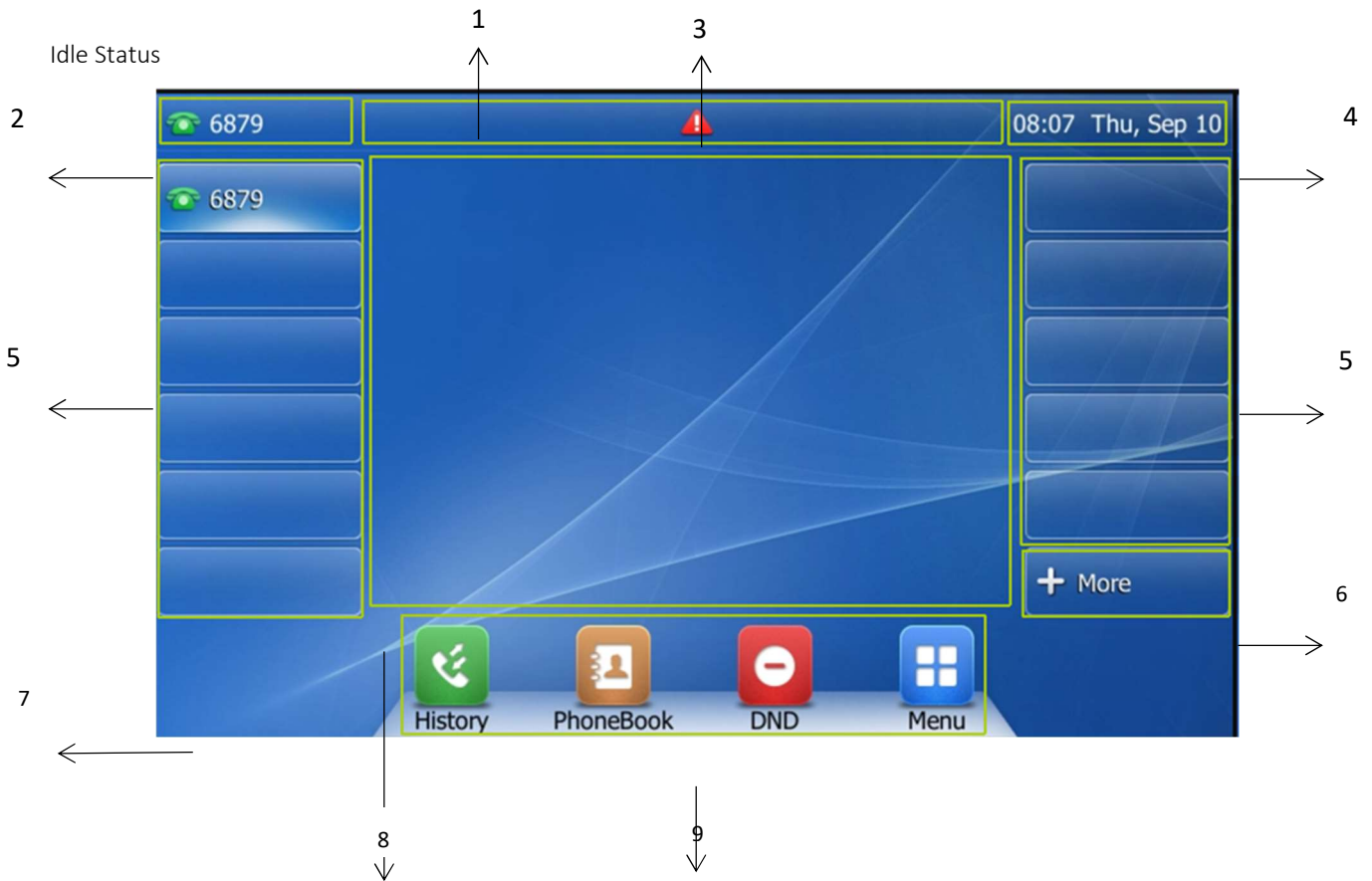

Icons	Description
	Wired network is unavailable
	Wired network is unreachable
	Wi-Fi connection is successful
	Wi-Fi connection is unreachable
	Wi-Fi connection fails
	Bluetooth mode is on
	Bluetooth headset is both paired and connected
	Bluetooth-enabled mobile phone is both paired and connected
	Registered successfully
	Register failed
	Registering
	Call forward is enabled on this line
	Hands-free speakerphone mode
	Handset mode

Icons	Description
	Headset mode
	Multi-lingual lowercase letters input mode
	Multi-lingual uppercase letters input mode
	Alphanumeric input mode
	Numeric input mode
	Multi-lingual uppercase and lowercase letters input mode
	Voice Mail
	Text Message
	Auto Answer
	Do Not Disturb
	Phone Warning
	Call Hold
	Keep Mute
	Ringer volume is 0
	Phone Lock
	Received Calls
	Placed Calls
	Missed Calls
	Forwarded Call
	Always Forward
	Busy Forward
	No Answer Forward
	Direct Pickup
	Group Pickup
	Transfer
	ReCall
	Conference
	Speed Dial
	Directory
	Hot Desking
	Phone Lock

Phone Display (Views)



No.	Name	Description
1	Status Bar	Displays the phone's default account, icons and the time and date.
2	Default Account	The label of the default account is displayed on the left of the status bar. If multiple accounts are already registered, tap and select the desired default account.
3	Icons	Icons are displayed in the middle of the status bar.
4	Time and Date	The phone's time and date are displayed on the right of the status bar.
5	Line Keys (1-11)	Use the Feature Management Portal to assign additional phone lines or Speed Dials to these keys.
6	DSS Key	Provides a quick access to the line key screen. Then, you can tap the desired line key to configure it.
7	Wallpaper	Shows the specified wallpaper, which can be customized.
8	Call Window	Displays call information.

No.	Name	Description
9	Shortcut Keys	 : tap this shortcut key to enter the History screen and view call history.  : tap this shortcut key to enter the Phonebook screen and view contacts.  : tap this shortcut key to toggle the DND mode or enter the custom DND configuration screen.  : tap this shortcut key to enter the main menu.

Touch Screen

T48U with a touch screen, so you can touch the Icon/Menu on the LCD screen to access the feature.



Phone Status

You can view phone status via phone user interface or web user interface.

Available information of phone status includes:

- Network status (e.g., IPv4 status, IP address mode, MAC address, LAN type, LAN IP and LAN mask).
- Phone status (e.g., device model, hardware version, firmware version and product ID).
- Account status (e.g., register status of SIP accounts).

To view the phone status via phone user interface:

1. Press , or press **Menu->Status**.
2. Press  or  to scroll through the list and view the specific information.



Time and Date

The time and date are set by the Service Provider. However you can change the format within the phone preferences from basic settings.

Basic Call Features

Placing Calls



You can use your phone like a regular phone to place calls in many ways easily:

- Placing a Call from the Dialler
- Placing Multiple Calls
- Redialling a Number
- Placing an International Call
- Placing a Call from the Call History
- Placing a Call from the Directory
- Switching Among the Handset, Speakerphone and Headset Modes

Placing a Call from the Dialler:

The Dialler enables you to enter a number to place a call, and it displays a list of previously placed calls or contacts in your directory.

You can also select the desired contact from the search list, the placed call list or Directory.

1. Do one of the following:
 - Start typing a phone number.
 - Select the desired line key.
 - Pick up the handset, press the Speakerphone key  or the HEADSET key .
2. Enter a number or select a contact.
3. Select **Send**.

The phone supports to match the number to show the contact in Directory no matter local format or international format is dialled.

Placing Multiple Calls:

When you are in a call, you can hold your current call and place a new call.

1. Do one of the following:
 - Select a line key. The active call is placed on hold.
 - Press the HOLD  key or **Hold** to place the original call on hold.
 - Select **New Call**.
2. Enter the desired number or select a contact.
3. Select **Send**.

Or

1. Press the HOLD  key or **Hold** to place the original call on hold.
2. Enter the desired number or select a contact.
3. Select **New Call**.

Redialling a Number:

The phone keeps a record of all the placed calls. You can recall the contact you recently called.

1. Press the REDIAL key 
2. Highlight the desired record, select **Send**.

Placing an International Call:

You can place calls to international phone numbers on your phone.

1. Long press digit key 0 on the phone keypad until the **plus sign (+)** appears.
2. Enter the phone number with the country code.
3. Select **Send**.

Placing a Call from the Call History:

You can place calls to contacts from the History list, which contains the calls that were recently placed, answered, missed, or forwarded.

1. Press **History** or navigate to **Menu->History**.
2. Select the desired call list.
3. Highlight a contact, and select **Send**.

Placing a Call from the Directory:

You can place a call to a contact directly from your directory.



1. Select **Phonebook** or navigate to **Menu->Directory->Phonebook**.
2. Highlight the desired contact, and select **Send**.

Switching Among the Handset, Speakerphone and Headset Modes:

You can select the desired mode before placing a call, or can alternate among Speakerphone, headset, and handset modes during a call.

When using the speakerphone or the headset, the LED indicator glows green.

1. During the call, pick up the handset, press the Speakerphone key  or press the HEADSET key 

For example, if you're using the handset, press the HEADSET key  to switch to the headset, or press the Speakerphone key  to switch to the speakerphone.

Answering Calls

When you receive an incoming call, the phone rings and the screen displays the information of the incoming call. You can choose to answer the incoming call.

1. Pick up the handset.
2. Press the Speakerphone key 
3. Press the HEADSET key 
4. Press **Answer** or the line key that has the flashing green LED indicator.

Transferring Calls

You can transfer a call to another party in one of the three ways:



- **Blind Transfer:** Transfer a call directly to another party without consulting.
- **Semi-Attended Transfer:** Transfer a call when the target phone is ringing.
- **Attended Transfer:** Transfer a call with prior consulting.

To perform a blind transfer:



1. Press the **Tran** soft key during a call.
2. Enter the number you want to transfer the call to.
3. Press the **Tran** soft key to complete the transfer.

Then the call is connected to the number to which you are transferring.

To perform a semi-attended transfer:

1. Press the **Tran** soft key during a call.
2. Do one of the following:
 - Enter the number you want to transfer the call to.
 - Press the **Directory** soft key to find the number of directory or History.
3. Press  or  to dial out.
4. Press the **Tran** soft key to complete the transfer when receiving ringback.

To perform an attended transfer:



1. Press the **Tran** soft key during a call.
2. Do one of the following:
 - Enter the number you want to transfer the call to.
 - Press the **Directory** soft key to find the number of directory or history.
3. Press  or  to dial out.
4. After the party answers the call, press the **Tran** soft key to complete the transfer.

If you are using a handset, the transfer can be completed by hanging up the handset. You can cancel the transfer before the call is connected by pressing the **Cancel** soft key.

Ending Calls

1. If you are using the handset, press the **Cancel** soft key or hang up the handset.
2. If you are using the headset, press the **Cancel** soft key.
3. If you are using the speakerphone, press  or the **Cancel** soft key.

Conference Calls

1. When the first party answers the call, press the **Conf** soft key to place a new call.
2. The active call is placed on hold.
3. Enter the number of the second party and press , , or the **Send** soft key.
4. When the second party answers the call, press the **Conf** soft key again to join all parties in the conference.

During the conference call, you can do the following:

- Press the **Hold** soft key to place the conference on hold.
- Press the **Split** soft key to split the conference call into two individual calls.

- Press the **New Call** soft key to place a new call.
- Press the **Back** soft key to return to the previous interface.
- Press  to mute the conference call.
- Press the **Cancel** soft key to drop the conference call.





Do Not Disturb (DND)

Press the **DND** soft key when the phone is idle. The **DND** icon on the idle screen indicates that DND is enabled. Incoming calls will be rejected automatically and "**n Missed Call(s)**" ("n" indicates the number of the missed calls) will prompt on the LCD screen.







History

To view the call history:

1. Press the **History** soft key. The LCD screen displays all call records.
2. Press  or  to switch between All, Placed, Received, Missed and Forwarded call lists.
3. Press  or  to select the desired entry.
4. Press the **Option** soft key, and then select Detail from the prompt list. The detailed information of the entry appears on the LCD screen.

To place a call from the call history list:

1. Press the **History** soft key.
2. Press  or  to switch between All, Placed, Received, Missed and Forwarded call lists.
3. Press  or  to select the desired entry.
4. Press the **Send** soft key.

Contact Directory

You can search for a contact, or simply dial a contact number from the corporate directory.



No.	Name	Description
1	Screen Title Area	Displays the title of the current menu screen.
2	Operation Option Area	Displays various operation options for different menu screens.
3	Menu Tree Area	Displays menu items. Tap the desired menu item to enter the corresponding feature configuration screen.
4	Configuration Area	Displays configuration items of the highlighted menu item in the menu tree area. You can configure feature settings in this area.
5	Soft Keys	Label automatically to identify their context-sensitive features.

To access your corporate directory

1. Press **Directory** Softkey
2. Select the desired remote group, and then press the **Enter** soft key.
3. The phone connects to load the corporate directory, and then the corporate contact list appears on the LCD screen.
4. Press the **Back** soft key to back to the previous interface.

5. Rectory and tap the contact. From the contact's information screen, tap the contact's phone number.

To search for a contact in the corporate directory:

1. Press **Directory** Softkey
2. Select the desired remote group, and then press the **Enter** soft key to load the corporate directory.
3. Press the **Search** soft key.
4. Enter a few continuous characters of the contact name or continuous numbers of the contact number using the keypad.

The contacts whose name or phone number matches the characters entered will appear on the LCD screen. You can place a call from the result list.

VoiceMail

When receiving a new voice mail, the phone will play a warning tone, and the power indicator LED will slow flash red. The LCD screen will display a prompt message and appear an icon.

1. When the phone user interface prompts receiving new voice mails and the power indicator LED slow flashes red, press  or the **Connect** soft key to dial out the voice mail access code.
2. Follow the voice prompt to listen to voice mails.

Additional Features

The phone supports RJ9 headset, USB headset, wireless headset adapter, Bluetooth dongle, Wi-Fi dongle, expansion module as accessories.

Please refer to the documentation of each accessory for details.

Headset

The phone supports RJ9 headset, USB headset, Bluetooth headset and wireless headset via EHS to handle calls.

To use headset

1. RJ9 headset: Connect RJ9 headset to the headset port of your phone.
2. USB headset: Connect USB headset to the USB port of your phone.
3. Wireless headset via EHS: Connect Yealink wireless headset adapter EHS40 to the USB port of your phone, connect your wireless headset to EHS40.

Bluetooth Dongle

The phone supports Bluetooth feature to connect Bluetooth headset and mobile phone. The phone supports to connect 2 Bluetooth devices at the same time.

To use Bluetooth

1. Bluetooth headset: Connect Yealink Bluetooth dongle to the USB port of your phone and enable Bluetooth feature, pair your phone with Bluetooth headset. You can Bluetooth headset to handle calls. Please refer to the documentation of the Bluetooth headset for headset operations.
2. Mobile phone: Connect Yealink Bluetooth dongle to the USB port of your phone and enable Bluetooth feature, pair your phone with your mobile phone. You can sync mobile contacts to your phone and handle mobile calls from your phone.

Wi-Fi Dongle

The phone supports Wi-Fi feature to connect wireless network.

To use Wi-Fi

Connect Yealink Wi-Fi dongle to the USB port of your phone and enable Wi-Fi feature. Scan and select the desired wireless network to connect.

Expansion Module

The phone supports expansion modules to expand programmable keys.

To connect expansion module

Connect first Yealink expansion module EXP43 to the USB port of your phone, connect second expansion module EXP43 to the USB port of the first expansion module EXP43, connect third expansion module EXP43 to the USB port of the second expansion module EXP43.

If you use more than one expansion module, you need to connect an additional Yealink power adapter (5V/2A) to any one of the expansion modules.

General information

Important

- Access to Emergency Services is provided but calls including emergency calls to 999 or 112, made via WHC may not work in the event of power or broadband connection failure. These failures may be caused by reasons outside our control. Location information, provided to the emergency services, is limited to the location details entered into the system by your Service Provider; this may not be where the call was originated.

Safety information

- Do not open the handset or the base. This could expose you to high voltages or other risks. Contact your Service Provider for all repairs.

Cleaning

- Clean the handset and base with a damp (not wet) cloth, or an anti-static wipe. Never use household polish as this will damage the product. Never use a dry cloth as this may cause a static shock.

Environmental

- Do not expose to direct sunlight
- Do not stand your product on carpets or other surfaces which generate fibres, or place it in locations preventing the free flow of air over its surfaces
- Do not submerge any part of your product in water and do not use it in damp or humid conditions, such as bathrooms
- Do not expose your product to fire, explosive or other hazardous conditions
- There is a slight chance your phone could be damaged by an electrical storm.

Product disposal instructions

- The symbol shown here and on the product means that the product is classed as Electrical or Electronic Equipment and should not be disposed with other household or commercial waste at the end of its working life.
- The Waste of Electrical and Electronic Equipment (WEEE) Directive (2002/96/EC) has been put in place to recycle products using best available recovery and recycling techniques to minimize the impact on the environment, treat any hazardous substances and avoid the increasing landfill.
- Business users should contact their suppliers and check the terms and conditions of the purchase contract and ensure that this product is not mixed with other commercial waste for disposal.



Guarantee

- Your IP Phone is guaranteed for a period of 12 months from the date of purchase.
- Subject to the terms listed below, the guarantee will provide for the repair of, or at the Service Provider or its agent's discretion, the option to replace the Phone or any component thereof, (other than batteries), which is identified as faulty or below standard, or as a result of inferior workmanship or materials.

The conditions of this guarantee are:

- The guarantee shall only apply to defects that occur within the 12-month guarantee period
- Proof of purchase is provided
- The equipment is returned to your Service Provider or its agent as instructed
- This guarantee does not cover any faults or defects caused by accidents, misuse, fair wear and tear, neglect, tampering with the equipment, or any attempt at adjustment or repair other than through approved agents
- This guarantee does not affect your statutory rights.

Product Support & Fault Handling

There is a wealth of information available from www.support.yealink.com specific to these devices. If you are still experiencing issues, then please raise a ticket with the support desk.

Telephone: 01603 859669

Email: support@r5n.co.uk